

Ff

Nombre _____

Conocimiento fonémico

Clase 8 • Ficha 1

1 Colorea los dibujos que comiencen con **f**.

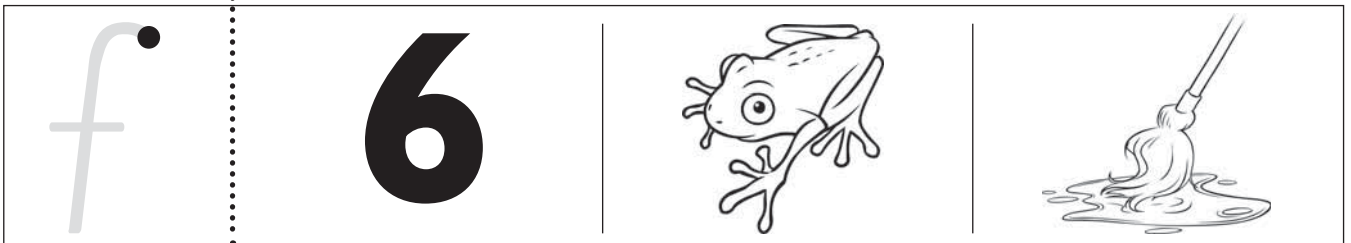
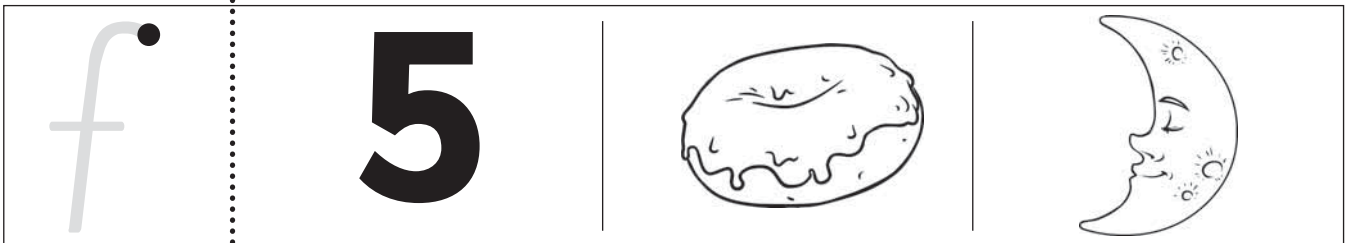
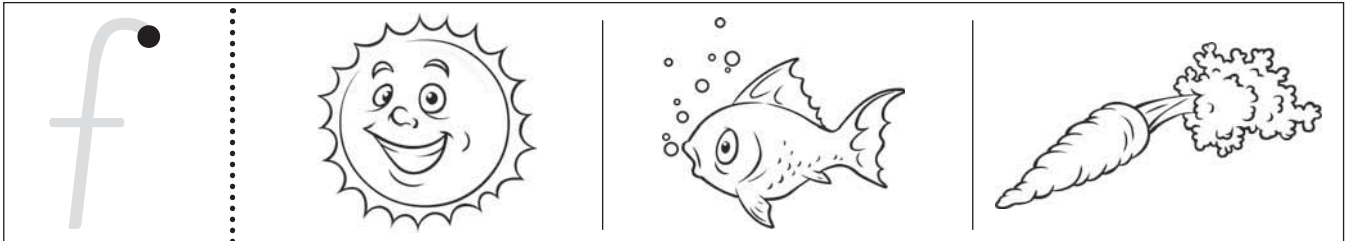

2 Une cada letra con un dibujo.

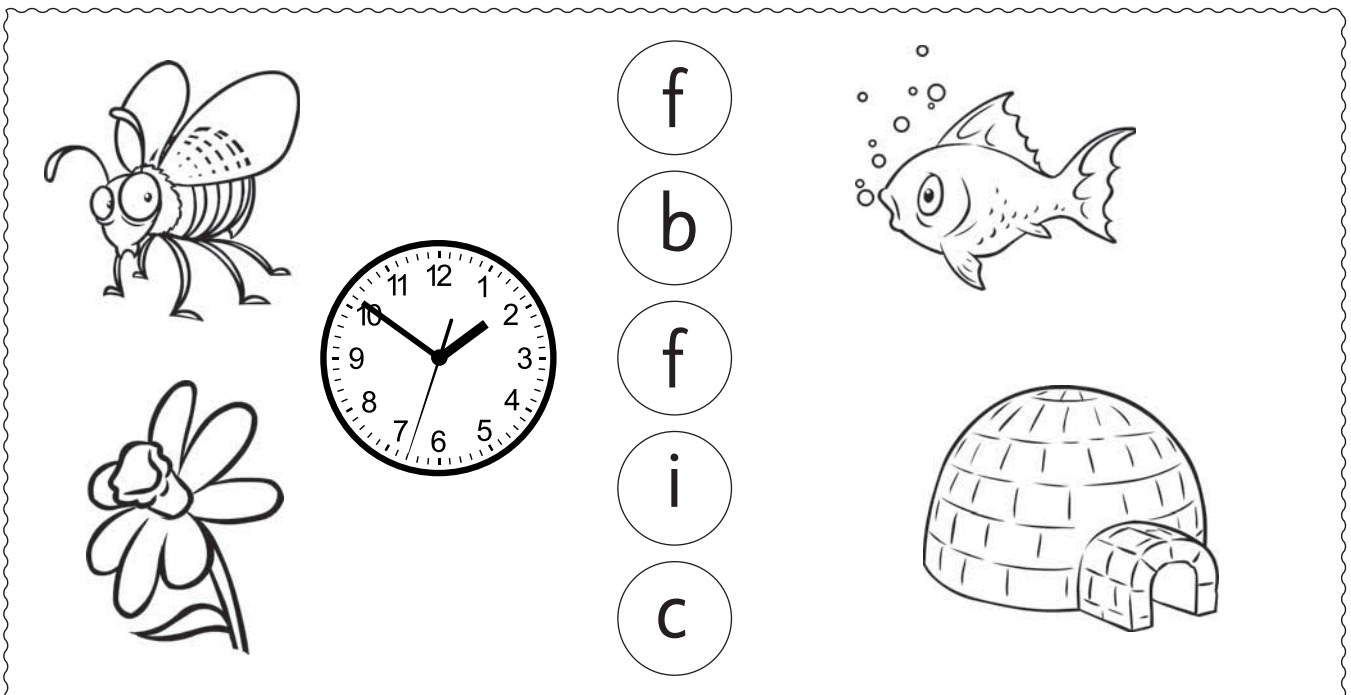

Nombre _____

Escritura

1 Completa las flores.

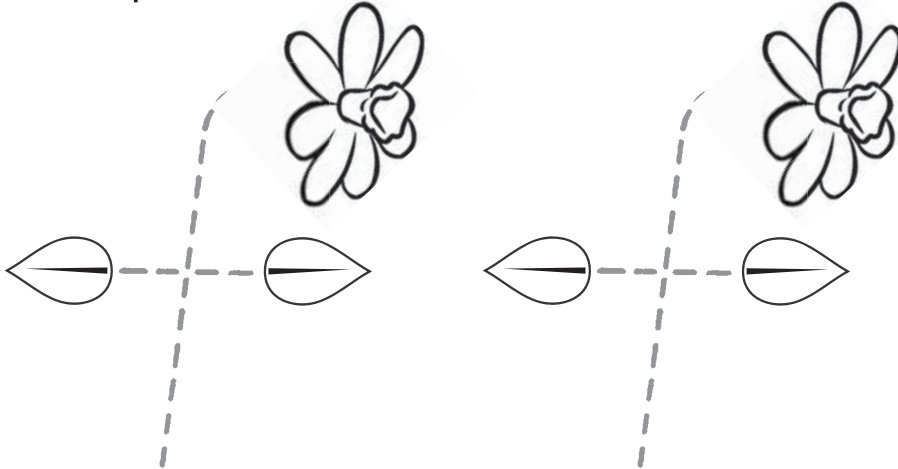

Ff

Clase 8 • Ficha 2

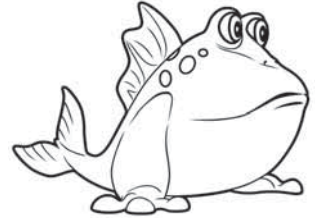

Hi, I'm
Frogfish I
have fins.

2 Traza y escribe.

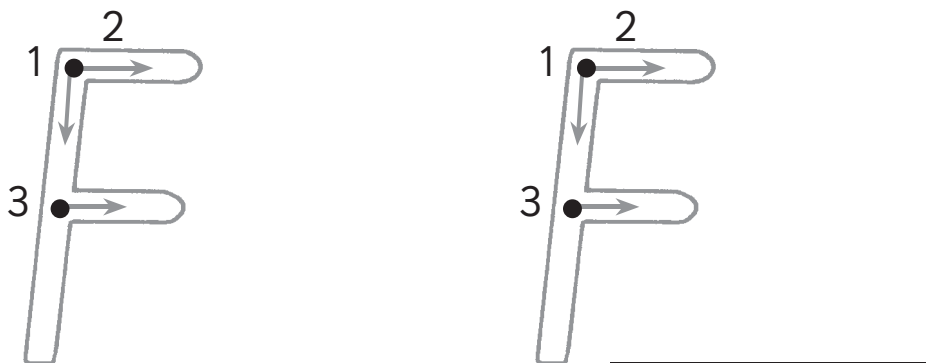
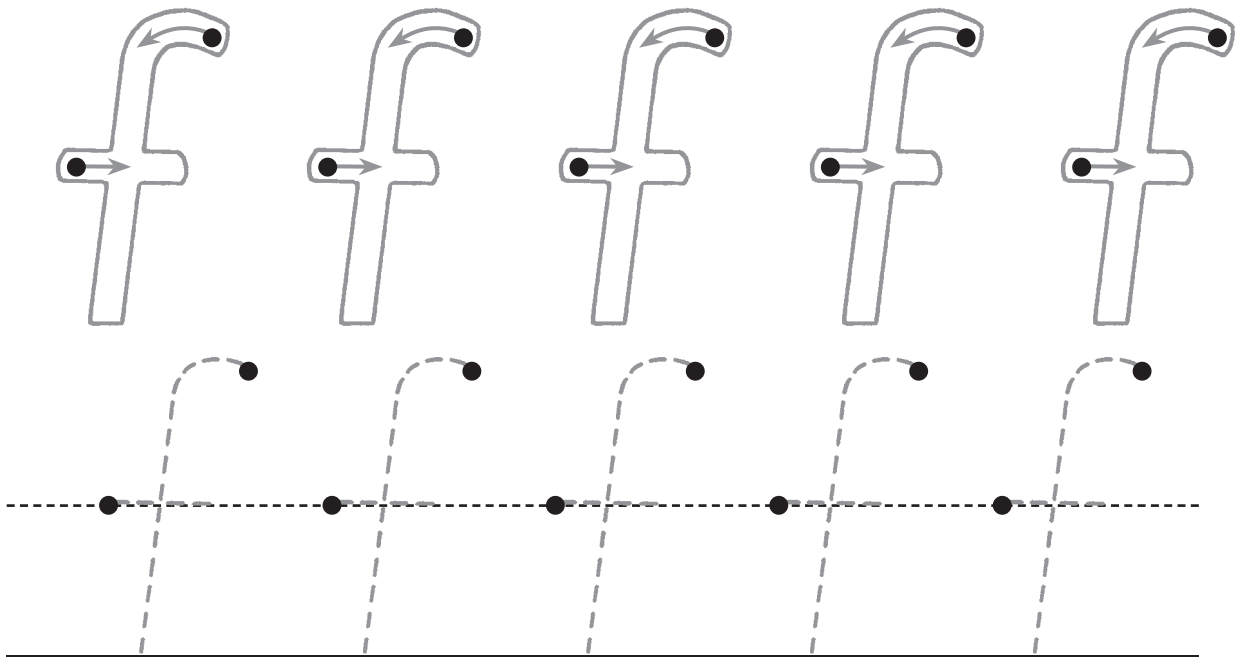

Redondea
tu mejor
letra.

Ff

Nombre _____

Clase 8 • Ficha 3

Sonidos iniciales



five flowers

1 Agrega la letra **f**. Lee la palabra.

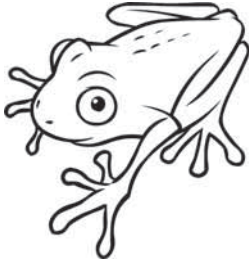

 f rog

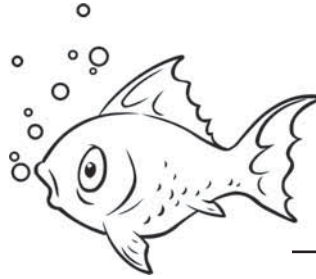

 ish



 oot



 ly

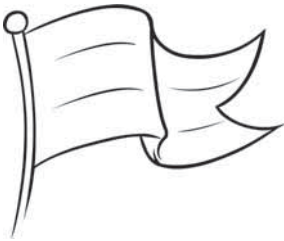

 lag

5

 ive



 inger













 ootball

2 Dibuja:
funny faces on
the fish

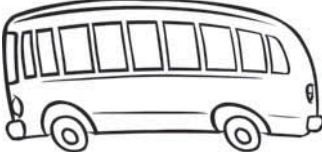

Vocabulario

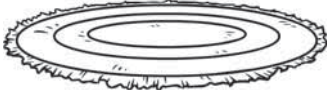
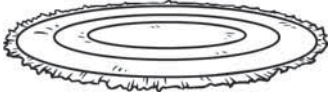
1 Lee la palabra. Colorea el dibujo que corresponde.

cat			
bat			
mat			
fat			

2 Dibuja: a **fat frog**

